

ASSEMBLY INSTRUCTIONS

WD2436

Step 1

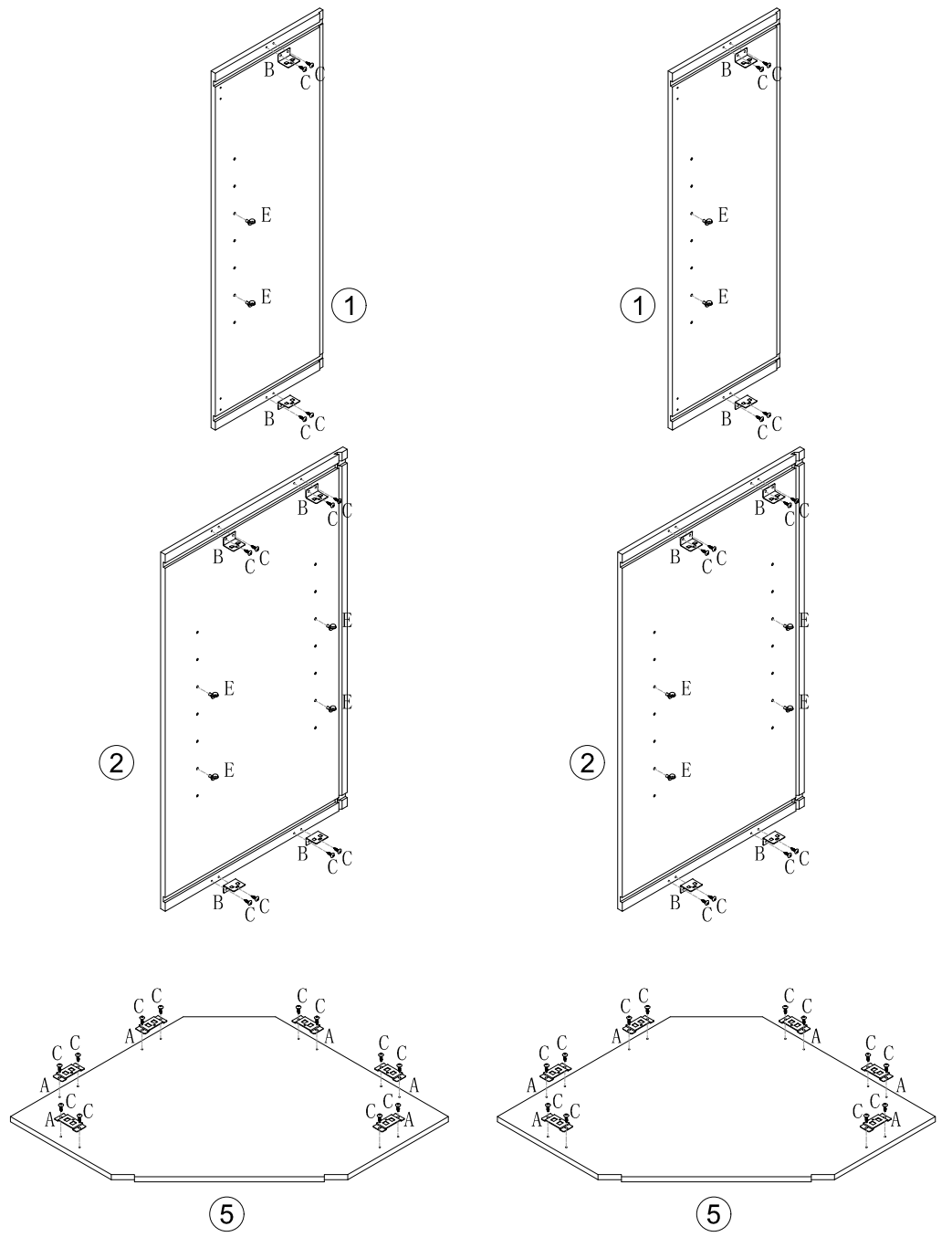
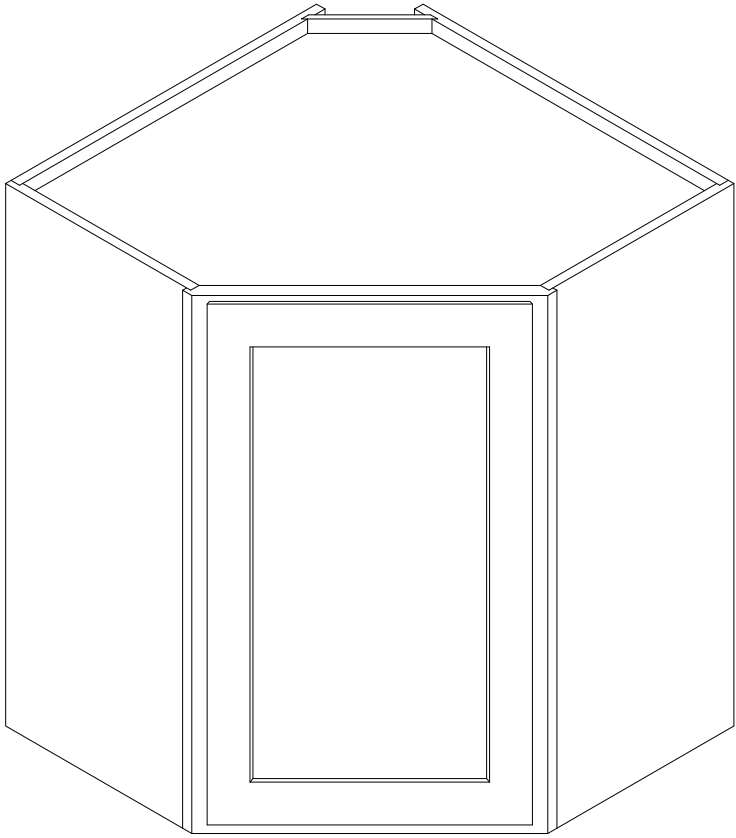

Parts list

NO.	Parts	QTY
A		12
B		12
C		60
D		16

NO.	Parts	QTY
E		12
F		2
G		4

Tools (required but not provided)

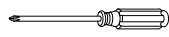

Step 2

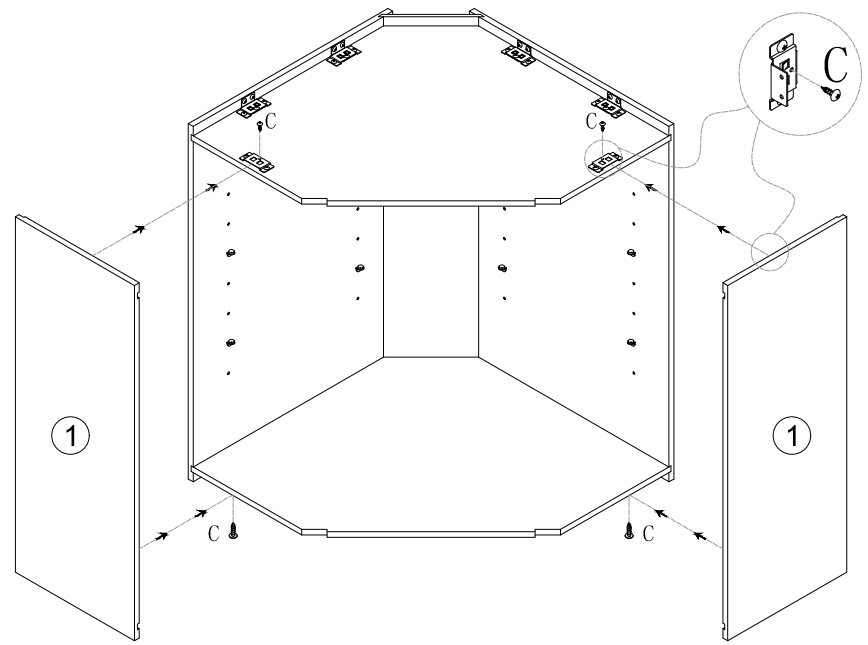
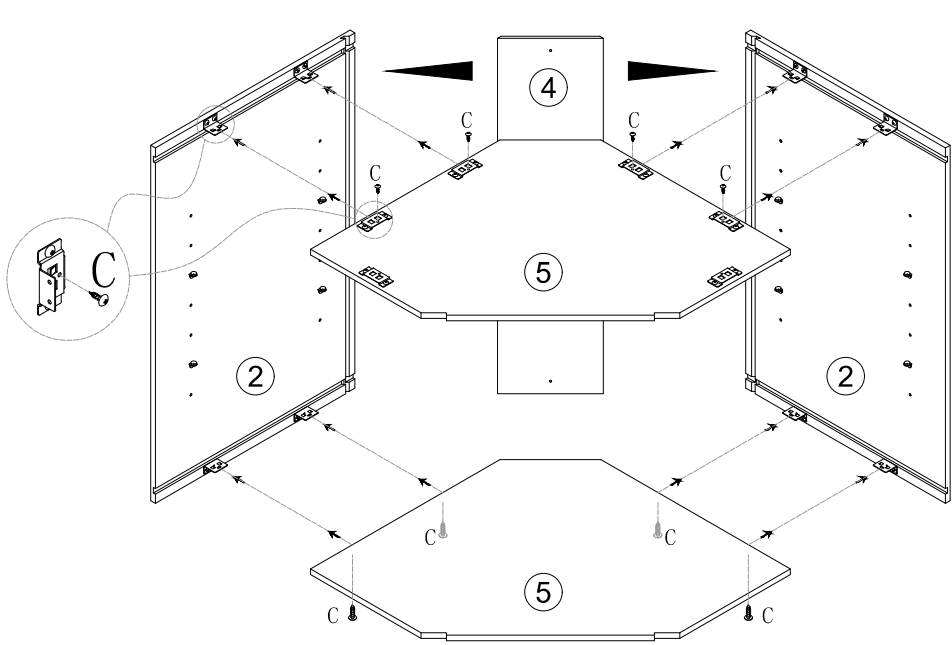

Step 3

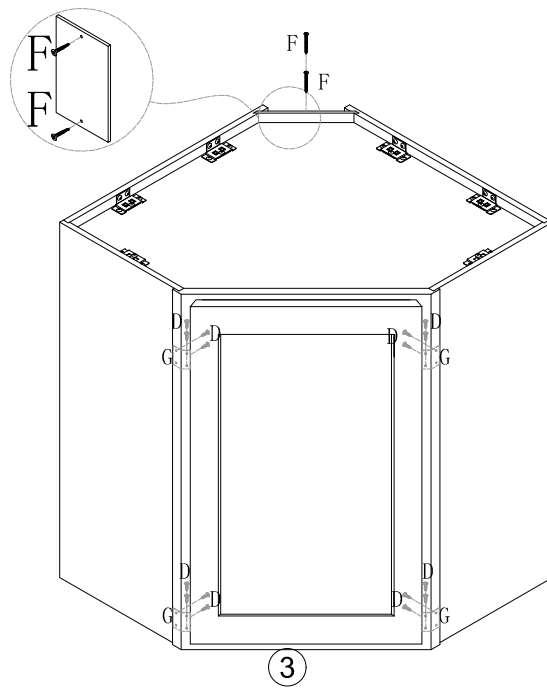
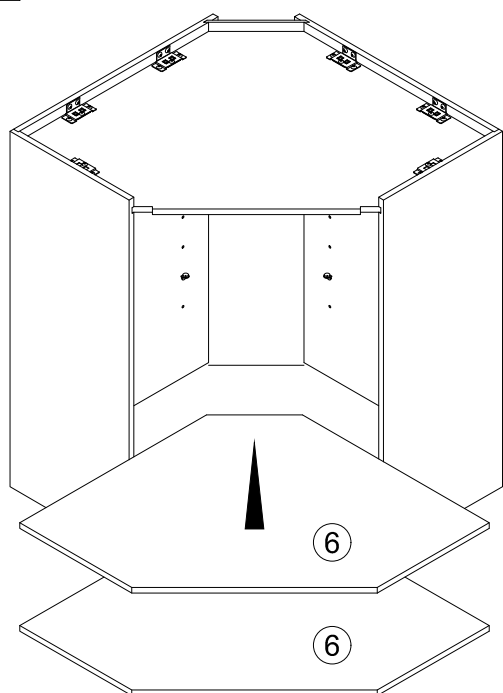

Finished

